

crydom[®]

LifePlus

ED Series

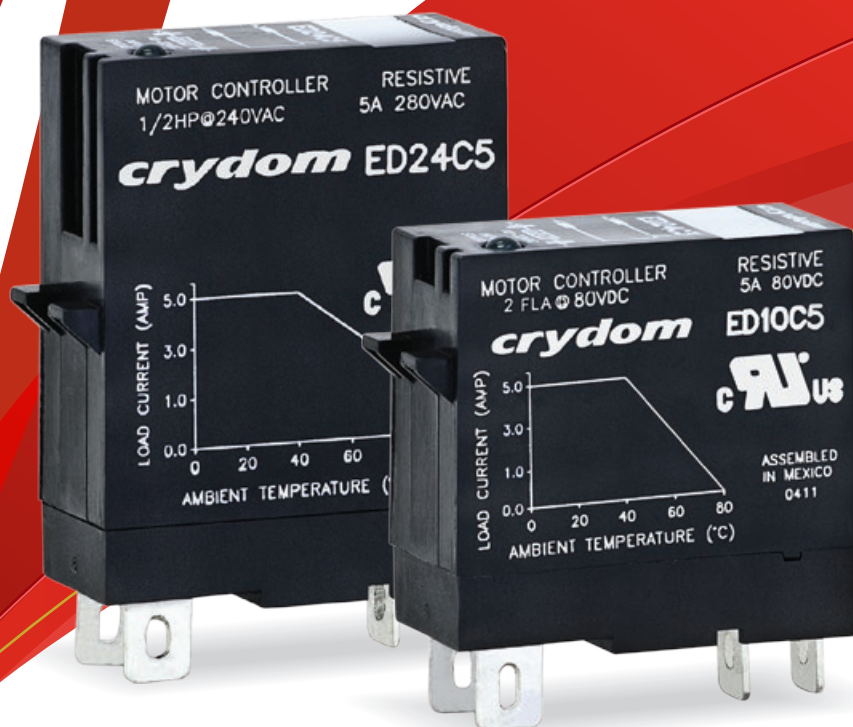

The Global Expert in **Solid State Relay** Technology

Sensata
Technologies

ABOUT US

Crydom, a brand of Sensata Technologies and **global expert in Solid State Relay Technology**, has a distinguished record of providing high quality, world class Solid State Relay and Control Products for a variety of heating, lighting and motion control applications. Crydom products, coupled with **unparalleled technical support, timely delivery and competitive pricing**, provide Crydom's clients with the innovative products and support necessary to succeed in today's competitive and fast paced global markets.

Crydom's extensive selection of standard off-the-shelf products is constantly being updated and expanded through its continuous improvement and aggressive new product development programs. Utilizing state of the art designs, materials and technology, Crydom offers a wide range of AC and DC output SSRs in industry standard Panel Mount, PCB Mount and DIN Rail packages, all **meeting global safety and standards agency requirements** such as CE, RoHS, UL, IEC, etc.

Bolstered by four decades of Solid State Relay operations experience, Crydom also specializes and encourages **adapted and fully custom-designed SSR products** for nearly any application where unique specifications and optimized performance are critical for success.

Crydom's modern purpose-built **100,000 square foot manufacturing facility** houses all aspects of its ISO certified operation including Design and Development Engineering, Manufacturing Operations and Quality Assurance, Customer Service, Finance, Marketing and General Management, permitting close coordination of all aspects of Crydom's activities. Applications Engineering and Sales support are both performed in the field to provide Crydom's Customers with the unparalleled technical and commercial support.

Following rigid design guidelines and standards, Crydom products have set the bench mark for SSR performance and reliability world wide. In addition to **award winning designs**, Crydom has acquired an impressive list of **patents** related to SSRs and Solid State Controls, while continuing to develop new circuit and technology-related inventions as part of **extensive R&D programs**.

To learn more about Crydom SSR technology and products, or how an alliance with Crydom can contribute to the success of your project, visit **www.crydom.com** or contact your authorized Crydom Distributor or Crydom Customer Service Representative today.

DIN RAIL OR PC MOUNTED PLUG-IN SOLID STATE RELAYS & SOCKETS "LIFEPLUS ED SERIES" PLUG IN SOLID STATE RELAYS

Crydom's new **"LifePlus ED Series"** of AC and DC Output Plug-in Solid State Relays are designed to replace industry standard 12 x 29 mm plug-in Electromechanical Relays. Crydom's proven Solid State Relay Technology offers substantial performance advantages over traditional EMR switching solutions in many applications including significantly greater life expectancy (>100 million operations), contactless high speed switching which eliminates contact bounce, arcing and resulting electrical noise, precise low power logic compatible control inputs, acoustically silent operation and high shock and vibration resistance.

Available in a SPST N.O. configuration, the **"LifePlus ED series"** offer output ratings of either 3 or 5 Amps rms at 24 to 280 VAC, or 5 Amps DC at 1 to 48 or 1 to 80 VDC, all at 40 °C ambient temperature. AC outputs incorporate Crydom's proven Back-to-Back SCR technology while DC outputs utilize high efficiency FETs, both technologies resulting in the lowest possible on-state power dissipation and high surge current ratings which makes the **"Crydom LifePlus"** an excellent choice for applications such as small Motors, Solenoids, Heaters and Lamps. Optically isolated control inputs available include 3 to 15 VDC, 18 to 32 VDC, 48 to 72 VDC, 18 to 36 VAC and 90 to 140 VAC.

Crydom's **"LifePlus ED Series"** are UL 508 recognized for general purpose, motor control and pilot duty applications, and compliant to IEC 62314 LC-A resistive and LC-B inductive application requirements. They are also CE certified to the IEC Low Voltage Directive and compliant to the IEC EMC directive.

"LIFEPLUS ED SERIES" DIN RAIL AND PCB MOUNT ACCESSORY SOCKETS

The **"LifePlus ED Series"** includes accessory sockets accepting the Crydom **ED Series** SSRs and industry standard 12 x 29 mm plug-in relay packages. One version socket fits standard 35 mm DIN rail while a second version is PCB mountable, allowing direct replacement of SPST N.O. EMRs in both type installations. Equipped with screws for wire termination and a positive latch for relay retention, the **"LifePlus ED Series"** sockets provide an easy means to install and utilize Crydom **ED Series** Solid State Relays.

Featuring all solid state construction, **"LifePlus ED Series"** SSRs and Sockets provide an excellent improvement in performance over traditional EMRs. For more information on **"Crydom LifePlus"** Series SSRs, contact the nearest Crydom Distributor, Representative or Local Crydom Sales Office, or visit our website at www.crydom.com.



ED Series AC Output Pluggable SSRs

- 12 x 29 mm industry standard plug-in package
- 3 & 5 Amps output power rating available
- 3 to 15 VDC, 18 to 32 VDC, 48 to 72 VDC, 18 to 36 VAC & 90 to 140 VAC control input options available
- Plug in replacement of EMRs
- Convenient Quick Connect terminals for PCB or direct wiring
- Fits standard DIN rail & PCB mountable sockets, also available as accessories
- UL & IEC Resistive/Motor/Pilot Duty Ratings available
- LED input status indicator
- Zero Voltage for resistive loads and Random Turn-On for inductive loads versions available

Output Specifications (A)

	ED24x3	ED24x5
Operating Voltage Range (47-63 Hz) [Vrms]	24-280 VAC	
Transient Overvoltage [Vpk]	600	
Maximum Off-State Leakage Current @ Maximum Operating Voltage [mA]	0.1	
Minimum Off-State dv/dt @ Maximum Rated Voltage [V/μsec]	500	500
Maximum Load Current [Arms]	3	5
Minimum Load Current [Arms]	150 mA	
1 Cycle Surge Current (50/60 Hz) [Apk]	240 / 250 (C)	600 / 625 (C)
Maximum I _t for Fusing (50/60Hz) [A ² sec]	285 / 260	1780 / 1620
Maximum On-State Voltage Drop @ Rated Current [Vpk]	≤1.1	
Minimum Power Factor (with Maximum Load)	0.5	
UL 508 Resistive Load @ 280 VAC [Arms]	3	5
UL 508 Motor Controller @ 240 VAC [HP]	¼	½
UL 508 Pilot Duty @ 120 V (Make/Break) [Amps] (B)	15 / 1.5	
UL 508 Pilot Duty @ 240 V (Make/Break) [Amps] (B)	7.5 / 0.75	
IEC 62314 LC-A @ 280 VAC [FLA]	3	5
IEC 62314 LC-B @ 240 VAC [Kw]	0.37	0.55

Input Specifications (A)

	ED24Dx	ED24Cx	ED24Fx	ED24E5	ED24B5
Control Voltage Range	3-15 VDC	18-32 VDC	48-72 VDC	18-36 VAC	90-140 VAC
Minimum Turn-On Voltage	3 VDC	18 VDC	48 VDC	18 VAC	90 VAC
Must Turn-Off Voltage	1.9 VDC	10.5 VDC	24 VDC	10 VAC	48 VAC
Maximum Reverse Voltage [VDC]	6				
Minimum Input Current (for on-state)	3.8 mA @ 3 VDC	3.8 mA @ 18 VDC	3.8 mA @ 48 VDC	3.8 mA @ 18 VAC	3.2 mA @ 90 VAC
Maximum Input Current	33.8 mA @ 15 VDC	6.9 mA @ 32 VDC	5.8 mA @ 72 VDC	8.5 mA @ 36 VAC	4.9 mA @ 140 VAC
Nominal Input Impedance [Ohm]	500	4.8 K	12.5 K	4.5 K	28 K
Maximum Turn-On Time [msec] (Zero Voltage)	1/2 Cycle (D)			1/2 Cycle (E)	
Maximum Turn-Off Time [msec]	1/2 Cycle (D)			1/2 Cycle (E)	

General Specifications (A)

	ED24x3	ED24x5
Dielectric Strength, Input to Output to Base (50/60Hz) [Vrms]	3750	
Minimum Insulation Resistance @ 500 VDC	10 ⁹	
Maximum Capacitance, Input to Output [pF]	10	
Ambient Operating Temperature Range [°C]	-30 to 80	
Ambient Storage Temperature Range [°C]	-40 to 125	
IP ratings	IP00 / IP10 when mounted in PCBSED / DRSED socket or equivalent	
Housing Material	PBT 30% GF, UL 94 V0	
Terminal Finish	Sulfamate Nickel	
LED Status Indicator for Control Input	On: Green	
Weight (typical) [oz] (gr)	0.705 (20)	1.06 (30)
Humidity	5 to 85% HR	
Terminal type / size [in] (mm)	Quick Connect / 0.187 x 0.02 (4.75 x 0.51)	

General Notes

- (A) All parameters at 25°C unless otherwise specified.
- (B) Pilot duty ratings, per UL 508, available for ED24D3, ED24D5 & ED24E5.
- (C) T_j = 25°C, time: 20 msec. (50 Hz) / 16.6 msec. (60 Hz).
- (D) Turn-On time for Random-type AC Output (R suffix) is 0.1 msec for DC Control Models, and for AC Control Models is 20 msec.
- (E) Turn-Off Time for AC output versions with AC control is 30 msec.
- (F) UL ratings are for relays only. To achieve maximum ratings, there must be a minimum spacing of 0.67 in (≥17 mm) between the devices in free air.
- (G) 100% Duty Cycle.

Derating Curves (F, G)

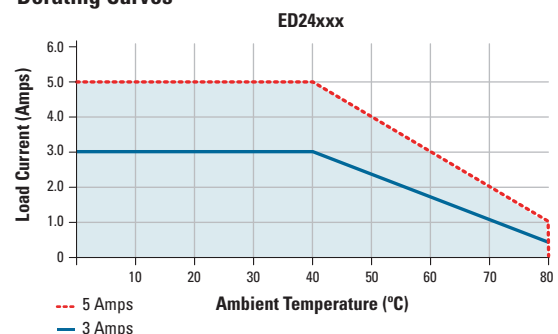

Part Number Nomenclature

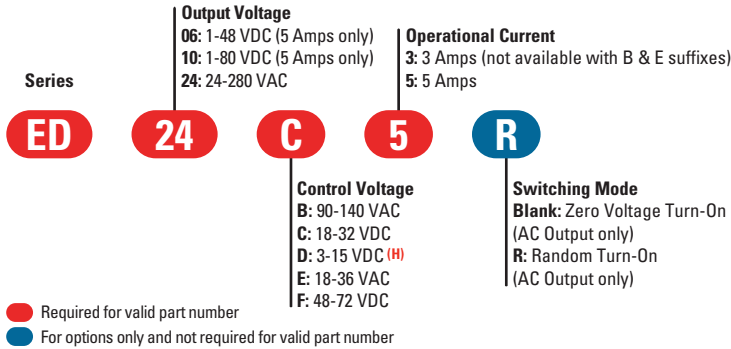

Mechanical Dimensions

Tolerances: ±0.02 in / 0.5 mm
 All dimensions are in: inches [millimeters]

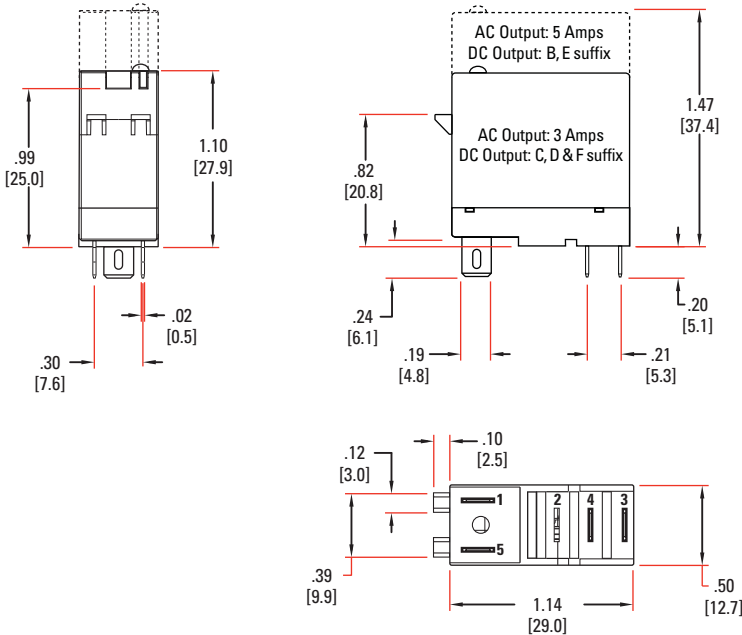

- (H) 5-15 VDC range for ED06/10D5
- (J) DC inductive loads must be diode suppressed.
- (K) No grounding required.
- (L) For sockets intended for AC input control voltage, the AC line can be wired to either DRSED socket terminal 1 (A1-) or terminal 5 (A2+). Proper polarity must be observed for DC input control voltage sockets being terminal 5 (A2+) positive with respect to terminal 1 (A1-).
- (M) For AC loads, the AC line can be wired to either DRSED socket terminal 4 (11) or terminal 3 (14). The AC load may also be wired on either the line or neutral side of the SSR. For DC loads, the proper polarity must be observed for the power supply, load and DRSED socket with terminal 3 (14) being positive with respect to terminal 4 (11).
- (N) Minimum wire strip length 0.197 in (5 mm), maximum 0.256 in (6.5 mm) for wiring socket DRSED.
- (P) Input / Output terminals screw M3 Combo Drive for socket DRSED.

Wiring Diagram (J,K)

RELAY (L,M)
 Part no.: ED series

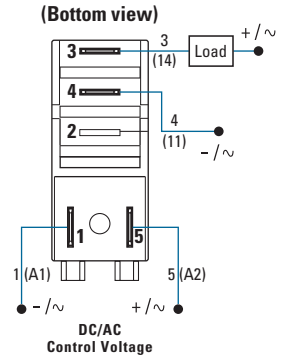

SOCKET
 Part no.: PCBSED

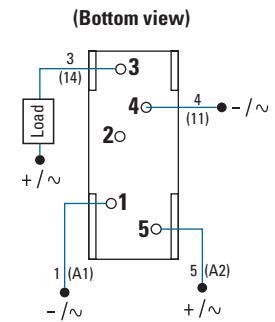

SOCKET (N,P)
 Part no.: DRSED

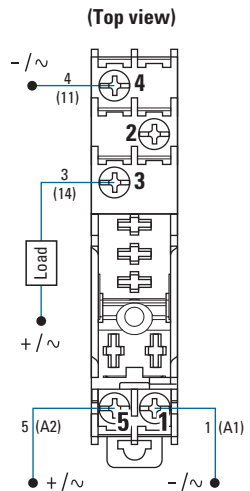

ED Series Accessories

DRSED



DIN Rail Mountable Socket

Part no.: DRSED
 Fingersafe IP10 DIN rail mountable socket to mount ED series relays onto standard 35 mm DIN rail. Rated at 250 V AC/DC, 12 Amps. The DRSED includes M3 Combo screws.

PCBSED



PC Board Mountable Socket

Part no.: PCBSED
 PC Board mountable socket for ED series relays. Rated at 250 V AC/DC, 12 Amps. Suggested Pin-out hole diameter: 1.0 mm



ED Series DC Output Pluggable SSRs

- 12 x 29 mm industry standard plug-in package
- 5 Amps output power rating
- 5 to 15 VDC, 18 to 32 VDC, 48 to 72 VDC, 18 to 36 VAC & 90 to 140 VAC control input options available
- Plug in replacement of EMRs
- Convenient Quick Connect terminals for PCB or direct wiring
- Fits standard DIN rail & PCB mountable sockets, also available as accessories
- UL & IEC Resistive/Motor Ratings available
- LED input status indicator

Output Specifications (A)

	ED06x5	ED10x5			
Absolute maximum operating voltage [VDC]	60	100			
Rated Voltage [VDC]	1-48	1-80			
	EDxxD5	EDxxC5	EDxxF5	EDxxE5	EDxxB5
Maximum Off-State Leakage Current @ Rated Voltage [μ A]			20 (Q)		
Maximum Load Current [A]			5		
Minimum Load Current [A]			0.1		
Maximum Surge Current (10ms) [ADC]			60 (R)		
Maximum On-State Voltage Drop @ 40°C Rated Current [VDC]			\leq 0.3		
Maximum On-State Resistance (RDS-ON) [Ohm]			0.034 (S)		
Maximum PWM (Hz)	500	500	500	N/A	N/A
UL 508 Resistive Load @ Rated Voltage [A]	5	5	5	5	5
UL 508 Motor Controller @ Rated Voltage [FLA]	2	2	2	1.5	1.5
IEC 60947-4-1 DC-1 @ Rated Voltage [ADC]	5	5	5	5	5
IEC 60947-4-1 DC-3 @ Rated Voltage [FLA]	5	5	5	5	5

Input Specifications (A)

	EDxxD5	EDxxC5	EDxxF5	EDxxE5	EDxxB5
Control Voltage Range	5-15 VDC	18-32 VDC	48-72 VDC	18-36 VAC	90-140 VAC
Minimum Turn-On Voltage	5 VDC	18 VDC	48 VDC	18 VAC	90 VAC
Must Turn-Off Voltage	1.3 VDC	2.0 VDC	4.0 VDC	4.0 VAC	11 VAC
Maximum Reverse Voltage [VDC]			3		
Minimum Input Current (for on-state)	11 mA @ 5 VDC	10.7 mA @ 18 VDC	10.8 mA @ 48 VDC	12 mA @ 18 VAC	7.3 mA @ 90 VAC
Maximum Input Current	42.8 mA @ 15 VDC	19.7 mA @ 32 VDC	16.3 mA @ 72 VDC	25.3 mA @ 36 VAC	10.9 mA @ 140 VAC
Nominal Input Impedance [Ohm]	350	1.6 K	4.4 K	1.5 K	12.5 K
Maximum Turn-On Time [msec]			0.6		
Maximum Turn-Off Time [msec]			0.3		

General Specifications (A)

	EDxxD5	EDxxC5	EDxxF5	EDxxE5	EDxxB5
Dielectric Strength, Input/Output/Base (50/60Hz) [Vrms]			2500		
Minimum Insulation Resistance @ 500 VDC			10^9		
Maximum Capacitance, Input/Output [pF]			10		
Ambient Operating Temperature Range [°C]			-30 to 80		
Ambient Storage Temperature Range [°C]			-40 to 125		
Housing Material			PBT 30% GF, UL 94 V0		
Terminal Finish			Sulfamate Nickel		
IP ratings			IP00 / IP10 when mounted in PCBSED / DRSED socket or equivalent		
LED Status Indicator for Control Input			On: Green		
Weight (typical) [oz] (gr)	0.705 (20)	0.705 (20)	0.705 (20)	1.06 (30)	1.06 (30)
Humidity			5 to 85% HR		
Terminal type / size [in] (mm)			Quick Connect / 0.187 x 0.020 (4.75 x 0.51)		

General Notes

- (A) All parameters at 25°C unless otherwise specified.
- (Q) Output Voltage is Maximum Operating Voltage, Control Voltage = 0 V, $T_j = 25^\circ\text{C}$
- (R) Output Voltage = 2.5 VDC
- (S) At maximum load current
- (T) UL ratings are for relays only. To achieve maximum ratings, there must be a minimum spacing of 0.63 in (≥ 16 mm) between the devices in free air
- (G) 100% Duty Cycle



To view available Installation Sheet scan the QR code with your smartphone or visit www.crydom.com

Derating Curves (T,G)

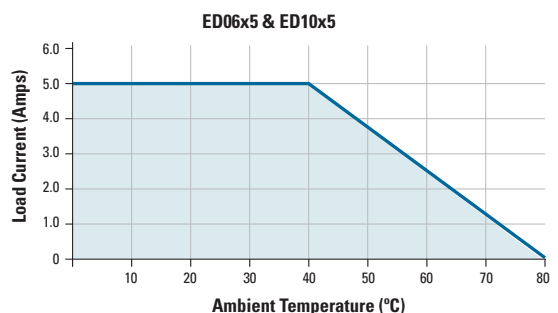

crydom[®]

AMERICAS



United States & Canada

2475 Paseo de las Americas
5014 San Diego, CA 92154

Sales Support

Tel.: +1 (877) 502 5500
Fax: +1 (619) 210 1590
sales@crydom.com

Technical Support

Tel.: +1 (877) 702 7700
support@crydom.com

Southern & Central American Countries

Tel.: +1 (877) 502 5500
Fax: +1 (619) 210 1590
sales@crydom.com

EUROPE, MIDDLE EAST & AFRICA



United Kingdom

Everdene House, Deansleigh Road
Wessex Fields, Bournemouth,
Dorset BH7 7DU

Sales Support

Tel.: +44 (0) 1202 416170
Fax: +44 (0) 1202 416171
sales-europe@crydom.com

Technical Support

support-europe@crydom.com

Austria & Switzerland

Tel.: +44 (0) 1202 416170
Fax: +44 (0) 1202 416171
vertrieb@crydom.com

Belgium

Tel.: +32 (0) 2460 4413
Fax: +44 (0) 1202 416171
sales-europe@crydom.com

France

Tel.: +33 (0) 1707 91389
Fax: +44 (0) 1202 416171
sales-europe@crydom.com

Germany

Tel.: +49 (0) 180 3000 506
Fax: +44 (0) 1202 416171
vertrieb@crydom.com

Italy

Tel.: +39 (0) 2360 26567
Fax: +44 (0) 1202 416171
sales-europe@crydom.com

Spain

Tel.: +34 902 876 217
Fax: +44 (0) 1202 416171
sales-europe@crydom.com

Netherlands

Tel.: +31 (0) 71 582 0068
Fax: +44 (0) 1202 416171
sales-europe@crydom.com

Middle East, Africa & Other European Countries

Tel.: +44 (0) 1202 416170
Fax: +44 (0) 1202 416171
sales-europe@crydom.com

ASIA



Great China

30th Floor
BM Intercontinental Biz Centre,
100 Yutong Road, JingAn District
Shanghai 200070

Sales Support

Tel.: +86 (21) 2306 1648
Fax: +86 (21) 2306 1601
sales-cn@crydom.com

Technical Support

support-cn@crydom.com

South Korea

7th floor of U-space 2, A Building
670 Daewangpangyo-Ro
Bundang-Gu
Seongnam-Si Gyeonggi-Do
South Korea. 463-400

Sales Support

Tel.: +82 31 601 2088
Fax: +82 31 601 2099
sales-cn@crydom.com

India and South East Asia Pacific

Level 9, Raheja Towers
M. G. Road
Bangalore, 560 001
India

Sales Support

Tel.: +91 80 6792 0879
sales-cn@crydom.com

© 2011 Crydom Inc., All Rights Reserved.

Specifications are subject to change without prior notice.
Crydom and the Crydom logo are registered trademarks
of Crydom Inc.

05/2011

CAT/CR/LP/EN

Distributed by :

Rev.102516